

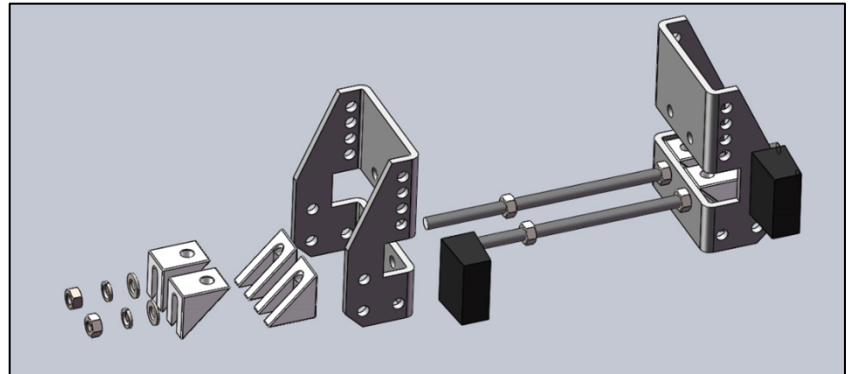

TROLLEY BEAM END STOP

Key Specifications:

- BEAM WIDTH: 3.2" TO 24.8"
- MAX BEAM THICKNESS: 1.25"



Clamps directly onto a beam's flange. Fully Adjustable.

The Bison End Stops are a great solution to simply clamp on stops for your monorail or bridge to prevent a hoist or trolley from traveling further than the clamping point. Fits W-Beams. Includes full assembly (nuts, bolts, buffer blocks, threaded rods, and brackets). The adjustable buffer blocks allow for compatibility of a wide range of hoist and trolley brands. The adjustable flange width accommodates for a variety of beam profiles.

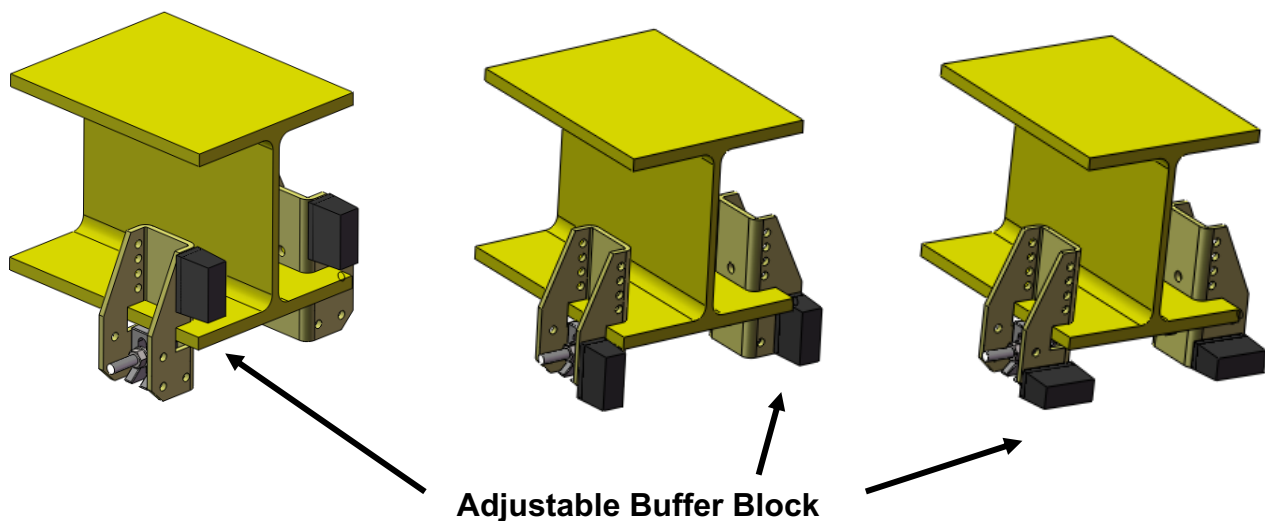

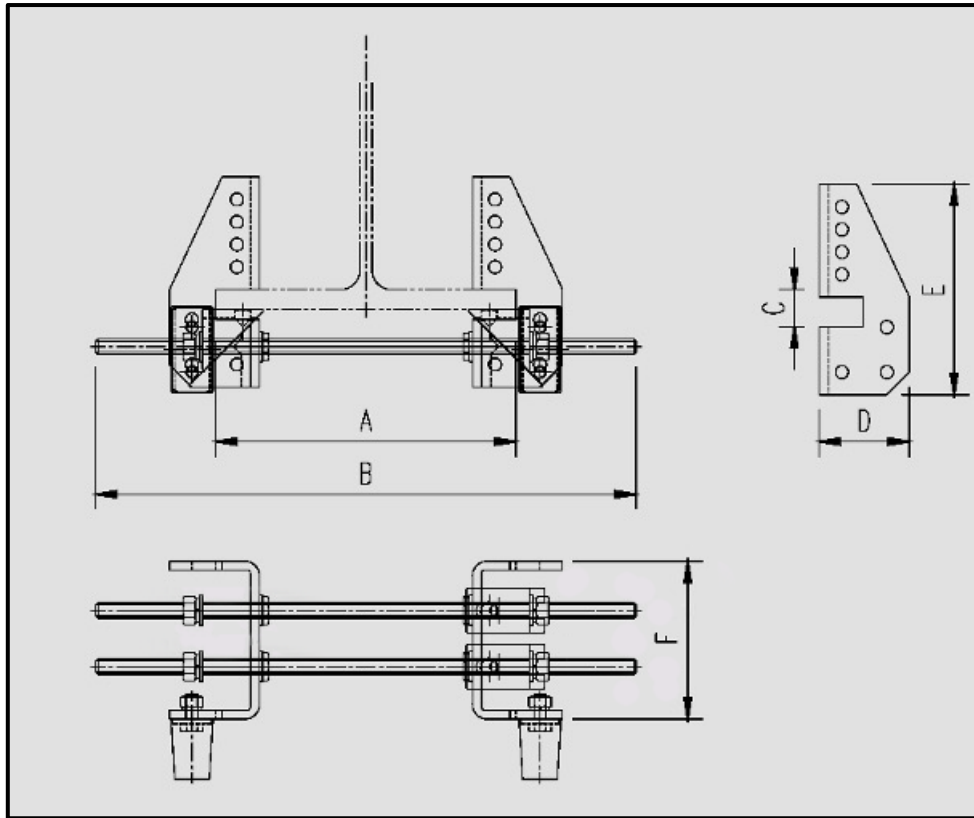

DIMENSIONS

A	B	C	D	E	F
3.2" – 24.8"	14.17"	1.25"	2.36"	5.9"	4.3"

- Galvanized Steel
- Impact Force 20,000 lbs. @ 33ft/min.
- Impact Force 4,000 lbs. @ 92 ft/min.

COMES WITH 2 CLAMPS PER KIT